

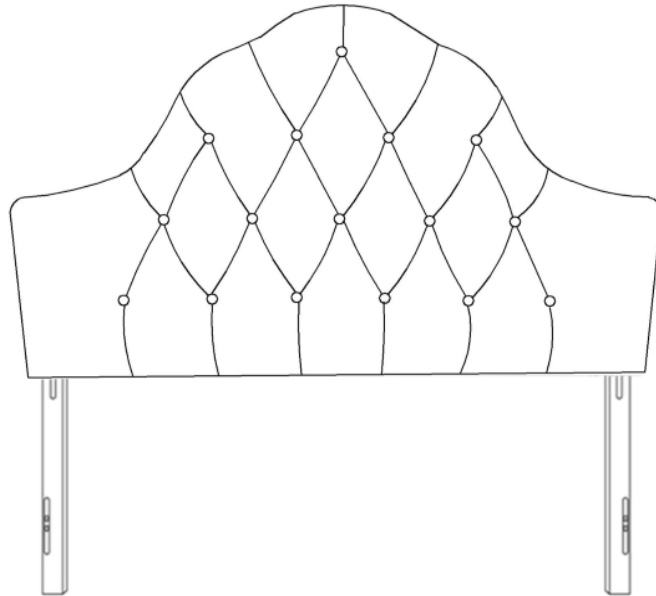

# Assembly Instructions

**Caution : You must read this before you proceed. This headboard must be used in conjunction with a Mattress Support Frame ( not included and not supplied with this headboard.)**





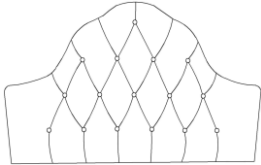

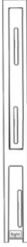
## Headboard



## Parts List

Part NO.	Picture	Description	Qty
A		Headboard	1
B		Left Support Leg with 3 Mounting Brackets (With the sticker "Left" on the bottom)	1
C		Right Support Leg with 3 Mounting Brackets ( With the sticker "Right" on the bottom)	1

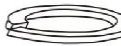
# Hardware

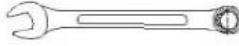

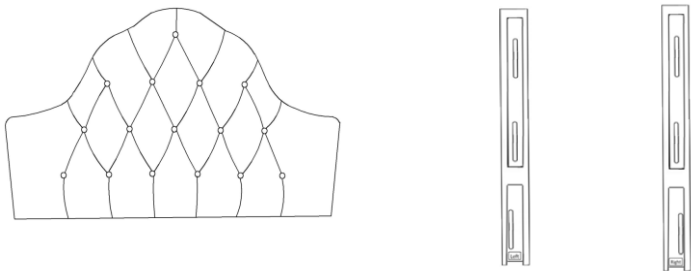
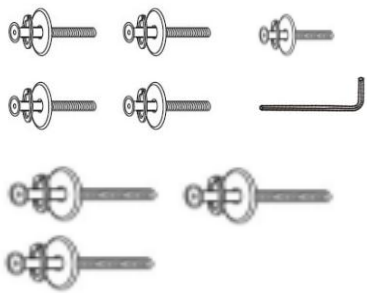

Label	Picture	Description	Qty
①		Bolt M8X25mm	9
②		Spring Washer Ring	9
③		Flat Washer Ring	9
④		Nut Cap	5
⑤		Bolt M8X50mm	4
⑥		Spring Washer Ring	4
⑦		Flat Washer Ring	4
⑧		Allen Key	1
⑨		Solid Wrench	1

## Assembly Preparation

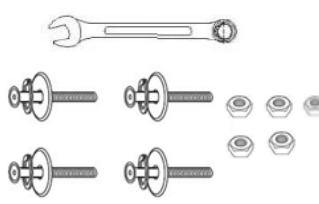
### Before Beginning Assembly:

<p><b>Unpack and place all parts for clear visibility.</b></p>		
<p><b>Pack A: For assembly the legs to the headboard and the Foldable Headboard</b></p>	<p><b>Assembly Lges: 4 Bolts (①) + 4 Flat Washers (③) + 4 Spring Washers (②) with the Allen key (⑧).</b>  <b>Assembly foldable headboard: 3 Bolts (⑤) + 3 Flat Washers (⑥) + 3 Spring Washers (⑦) with the Allen key (⑧)</b></p>	

<p><b>Pack B: For assembly the legs to the bed frame</b></p>	<p><b>4pcs M8X25mm bolts(①)+ 4pcs of Flat Washer Ring(③) + 4pcs Spring Washer Ring(②)+4pcs Nut Cap(④) with a Solid Wrench(⑨).</b></p>	
--	---	--

-  • Read instructions, cover to cover-
-  • Have 2 adults on hand for assembly-
-  • Do not assemble on flooring or carpet-
-  • Assemble on a clean non-marring surface (packing foam)-
-  • Save all packaging until finished-

## Assembly Steps

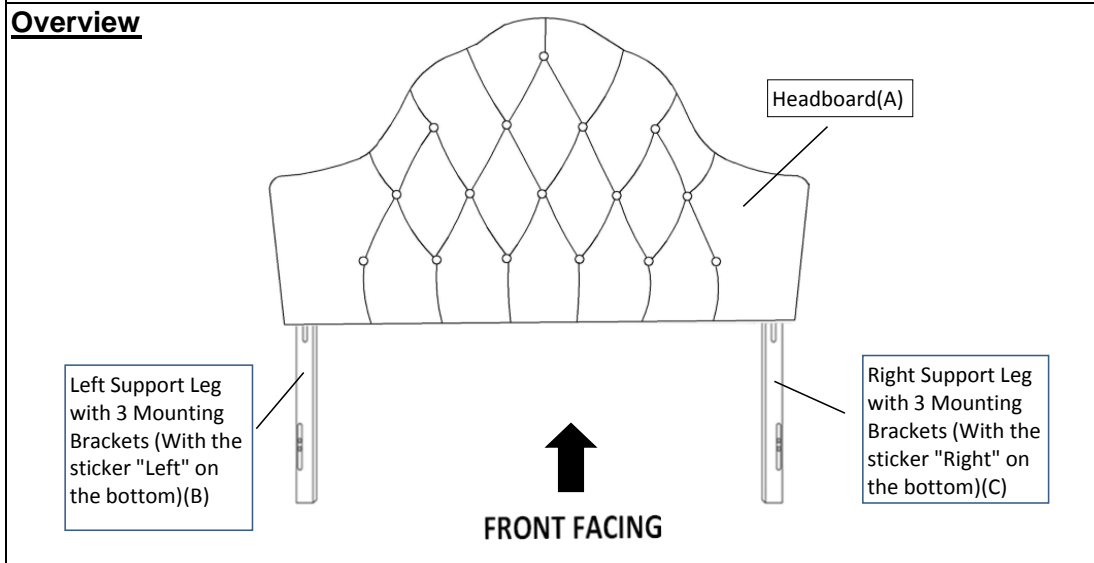

**This Headboard has multiple parts and may require up to 30 minutes to assemble. To give you an overview of the Bed parts, the above picture is to help you put the various Bed parts into perspective. Please read through the instructions herebelow to familiarise yourself with the parts and steps before assembly.**

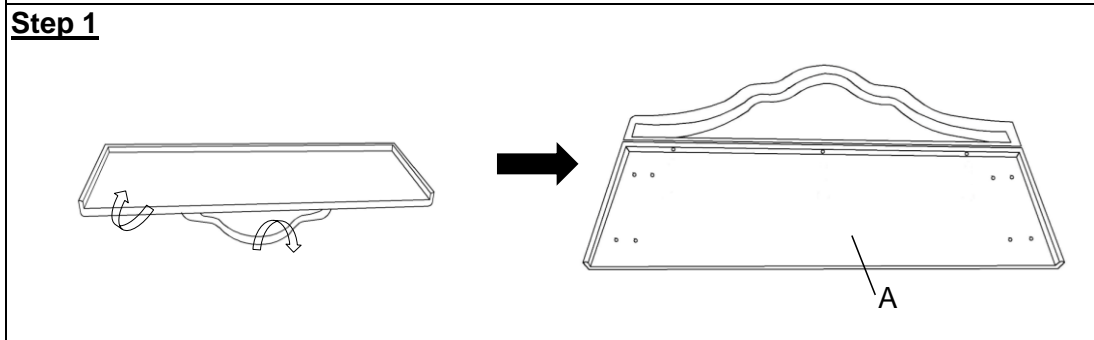

Place the Foldable Headboard(A) onto a clean, non-marring surface.  
Unfold the Headboard(A).

**The Headboard is Heavy. Two adults are required whenever lifting and moving it.  
Make sure the fabric does not get stuck when unfolding the Headboard.**

### **Step 2**

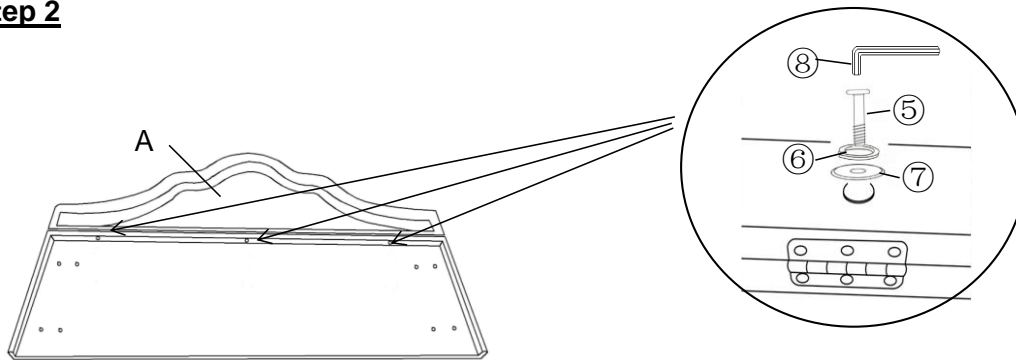

Secure the upper fold of the Headboard(A) using Bolts(5), Washers(7), and Spring Washers(6) with Allen Key(8).  
**Tighten the Bolts.**

### **Step 2**

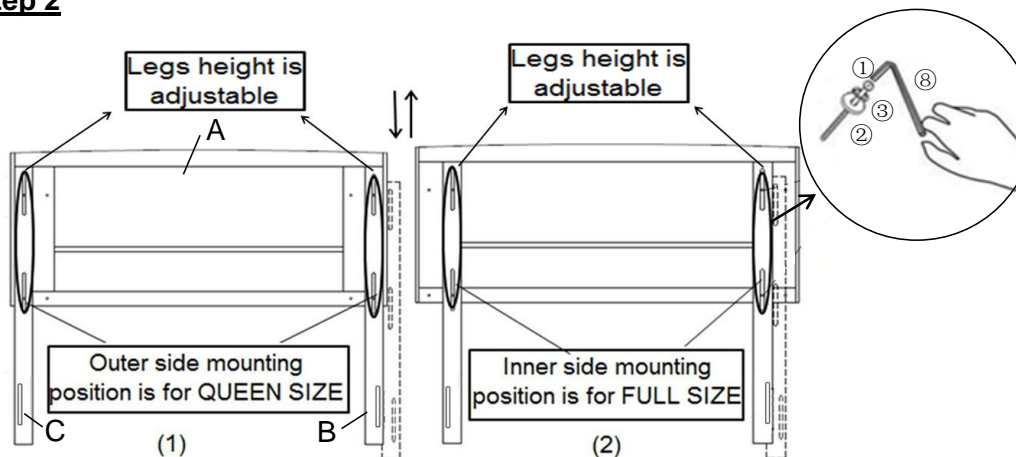

Put the Headboard(A) onto a flat table or panel.  
With assistant to your adult partner. One person hold the headboard(A) and another person hold the Support Leg(B)  
Align the mounting position on Headboard(A) to the top and middle mounting positions on Left Support Leg(B).

Then, lock the top and the middle mounting positions(use Pack A).  
The hardware for Pack A : 4 Bolts (1) ,4Flat Washers (3) ,4Spring Washers (2) with the Allen key(8).  
Attach Left Support Leg(B) to the Headboard(A)using Bolts (1), Washers (3), Spring Washers (2) with the Allen key(8).

**Tighten to only 70% tightness.**  
**Repeat the same steps to install the Right Support Leg(C).**  
**At this point of assembly, DO NOT over fasten the connections.**  
**The final height of the Headboard may be adjusted to your own need.**

**Note:Queen size assembly as picture (1) show;Full size assembly as picture (2) show.**

## To assembly the headboard to Mattress Support Frame

### Step 2

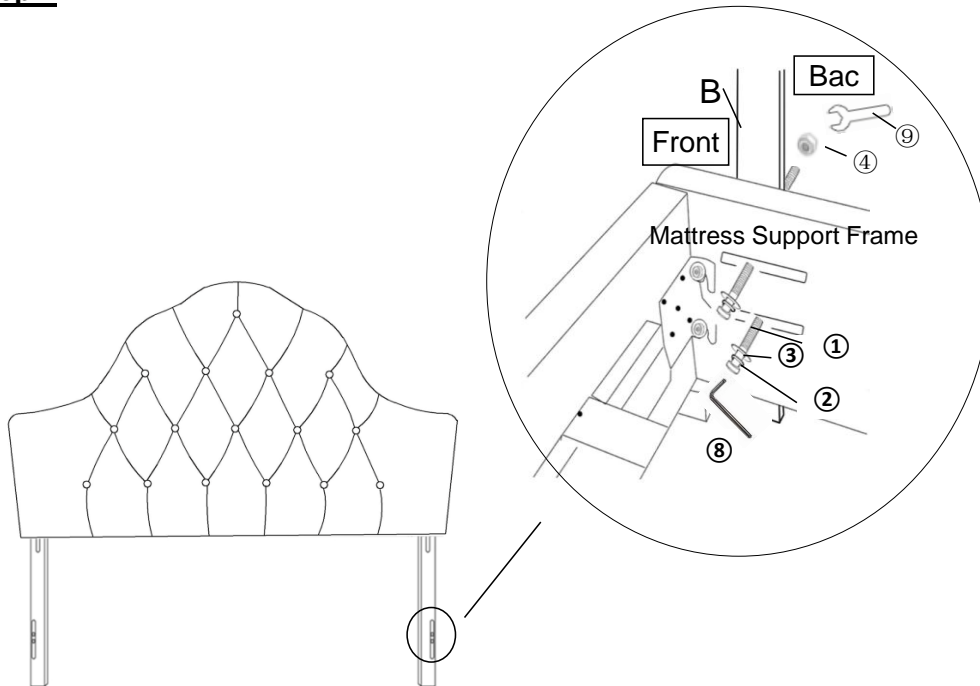

To assembly the headboard to your platform.

With assistant to you adult partner.

One person hold the Headboard upright and another person align the Headboard bottom mounting positions to the Mattress Support Frame mounting positions.

Attach the Headboard to the Mattress Support Frame using Pack B.

The hardware for Pack B: 4bolts(①),4Washers(②), 4Spring Washers(③) and 4Nuts(④) with Allen Key(⑧) and Wrench(⑨).





















Please install the bolts from the FRONT TO BACK of the headboard.

Make sure all parts are connected and securely locked into position.

Your headboard and Mattress Support Frame is ready for use.

**Caution: This headboard and Mattress Support Frame can only be used on a flat, level surface.**

## Care & Maintenance

-   • Do not put hot items directly on furniture surface.
  -   • Do not clean furniture with harsh cleansers or polish.
  -   • Do not place furniture under direct sunlight.
  -   • Do not place furniture near heating or cooling vents.
  -   • Do not write on furniture without a padded barrier to protect the surface.
  -   • Do not place furniture outside . For indoor use only .
  -   • Not for commercial use. For residential use only .
  -   • Stains may be removed with mild soap solution and damp cloth.
  -   • Children should not climb or jump on the furniture.
- 
-   • Dust and pick-up spills using a clean, non-colored, lint-free cloth .

### What is Proposition 65?

Proposition 65 is a California law that requires warning labels on products that may contain one of more than 800-plus chemicals or ingredients that the California Office of Environmental Health Hazard Assessment (OEHHA) has deemed to cause cancer or other reproductive toxicity. Chemicals and elements on this list include wood dust, brass, and other everyday substances, which can be found in very common household items, such as: lamps, tableware, jewelry, crystal glasses, electric cords, beauty products, automobiles, and furniture.

### Why Did I Find a Proposition 65 Warning on My Home Goods Product?

We include Proposition 65 warnings on all of our products because there is always a chance that one of the 800-plus common chemicals and ingredients listed under this law could potentially be on our furniture or packing materials. We risk large fines under this law, if we don't include this warning.

### Should I worry?

We realize you may be worried finding this warning on our products, but we want to reassure you that the hazardous exposure limits for any of these chemicals have never been found on furniture products that we've shipped to our customers. Additionally, this warning label is very common and can be found on almost every piece of furniture sold in the state of California.

### Just How Common Are Proposition 65 Warnings?

Proposition 65 warnings have become so common in California that it is hard to take a trip to a local bank, grocery store, or restaurant without finding at least one warning. In fact, even the Disney Land Resort has a Proposition 65 warning:

